



EZY SWITCH



SMS-TEMP-4 System Monitor Installation Manual

Table of Contents

COMMANDS

Getting Started – Setting Up Initial User	7
Adding a User	8
Removing a User	8
Adding an Administrator	8
Removing the Administrator	9
Get a list of all the Users	9
Turn programmed numbers lookup on or off	9
Text all programmed numbers on or off	9
Turn All Texts OFF and Disable Inputs	10
Turn All Texts ON and Enable Inputs	10
Testing	10
Get a List of the Inputs	10
Get a List of the Outputs	10
Naming Inputs/Outputs and Changing Names	11
Change the Input Delays	11
Change Input to Normally Open or Normally Closed	12
Set Input as a latched Input	12
Set Input as a non-latched Input	12
Reset latched Input	12
Masking Inputs	12
Link an Input to an Output	13
Get linked information	13
Setup Input Tick off	13
Programming the Input reply message	14
Turn an Output ON or OFF	15
Turn an Output ON for a set time	15
Invert Output	15
Make an Output Pulse On and Off	16
Clear Output Pulse (Set to non-pulsed)	16
Make output public	17
Turn Output response On / Off	17
Save Output Status	17
Linking Outputs	17
Set Battery Alarm trigger voltage	18
Link Battery Alarm to Output	18
Check Battery Supply Voltage	18
Latching / Non-latching battery alarm	19
Reset Latched Battery Alarm	19
Alive text	19
Get Firmware Version	20
Resetting Unit	20
Get Signal Strength	20
Reset Unit to Factory Defaults	20
Get temperature	19
Set temperature alarms	21
Set temperature alarm reset temperatures	21
Turn temperature alarms On/Off	21
Set temperature alarm delays	21
Link temperature alarms to outputs	22
<u>Appendix One</u>	
Table of User Selected Input and Output Names	24
Detailed Explanation of Input Delays	24
Trouble Shooting Guide	25
<u>Appendix Two</u>	
SMS-TEM-4 Application Notes	27-30

Features - *Model SMS-TEMP-4*

- Receive text messages on your cell phone alerting you to potential problems anywhere in the world
- Send commands to control lights, pumps, appliances, air conditioning, etc. via text message from your cell phone
- Module= Model A = 2G, B = 3G, C=3G/4G
- Up to 5 cell phones may be designated as “users” to send commands and receive alert text messages
- All set-up and changes made via text (no need for a computer)
- Control up to four (4) devices using text message commands
- Monitor up to three (3) devices that use switched contacts (switching Inputs which use contacts that open or close upon activation such as a float switch):
- Monitor temperature -25 to 80 degrees
 - Programmable Input delays (max 99 minutes)
 - Programmable for Latching or Non-Latching Inputs
 - Programmable for Normally Open or Normally Closed Inputs
 - Programmable for Normally Open or Normally Closed Outputs
- Inputs and Outputs names are user programmable via text command – up to 20 characters
- Link any Input to any Output (Example: Link intruder sensor or smoke detector [input] to light or alarm horn [output])
- Monitors battery supply voltage and sends alarm message if low battery is detected at below the programmed alarm setting
- On-demand updates via text message to interrogate status of:
 - Current battery voltage
 - Status of all Inputs
 - Status of all Outputs
 - List of all designated “users”
- Compact Size for wall or horizontal surface mounting:
 - 117mm x 78mm x 30mm

Monitor:

- Shore power disconnect
- Pumps running
- High water alarms
- Security & alarms
- Entry alerts
- Smoke alarms
- And much, much more

Control:

- Battery charger
- Fridge/Freezer
- Air Conditioning/Heating
- Lighting
- Hot water systems
- Irrigation systems
- Or any other device

System

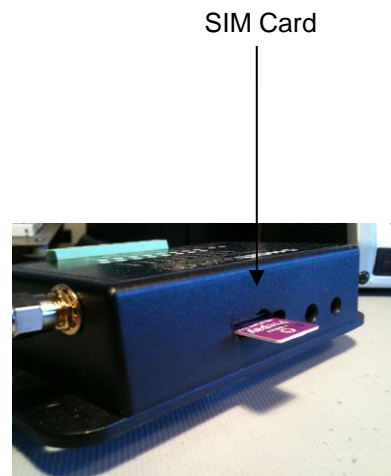
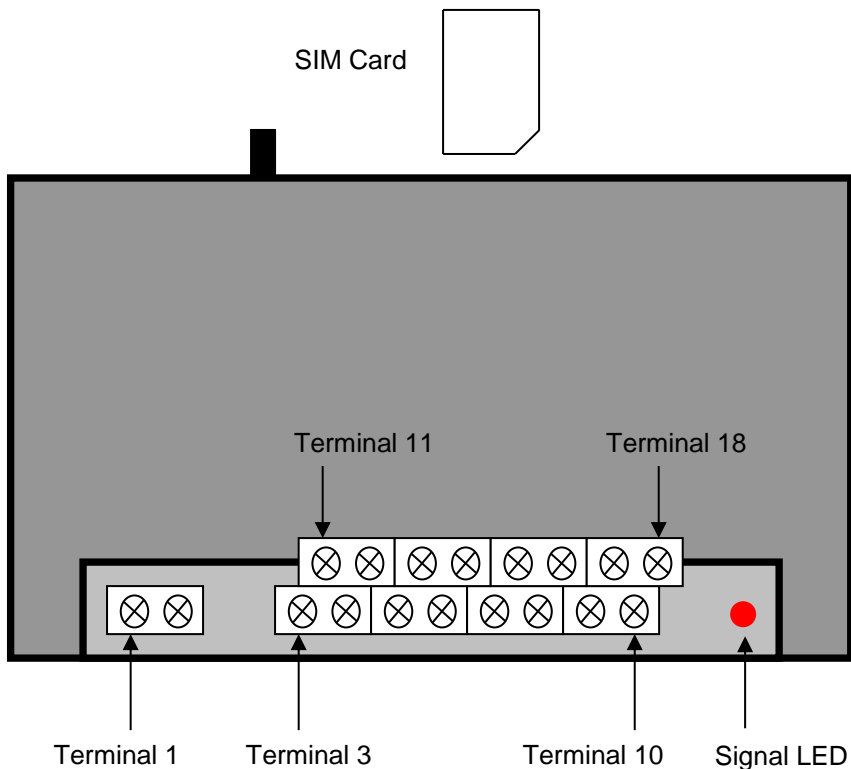

Signal LED:

If the LED flashes once every 1 second, this indicates the cellular network cannot be found (out of GSM coverage range). Remedy = Re-locate the device or use a longer aerial or signal booster.

If the LED flashes once every 3 seconds, this indicates the cellular network has been found (all ok).

SMS-TEMP-4 Terminal Electrical Connections

Terminal 1 = Batt +
Terminal 2 = Batt -

Terminal 3 = Temperature sensor
Terminal 4 = Temperature sensor
Terminal 5 = Input 1
Terminal 6 = Input 1
Terminal 11 = Input 2
Terminal 12 = Input 2
Terminal 13 = Input 3
Terminal 14 = Input 3

Terminal 7 = Output 1
Terminal 8 = Output 1
Terminal 9 = Output 2
Terminal 10 = Output 2
Terminal 15 = Output 3
Terminal 16 = Output 3
Terminal 17 = Output 4
Terminal 18 = Output 4

Electrical Specifications:

Supply Voltage	12 to 30 Volts DC @ 800mA
Quiescent Current	20 Milli-amps
Data Retention	10 years (without power)
Outputs	Relay = 3 A resistive @ 125VAC
Max Input voltage	30vdc

Outputs

The unit has two (4) Outputs. The Outputs are Relays rated at 3 A resistive @ 125VAC

Relay 1 Connection

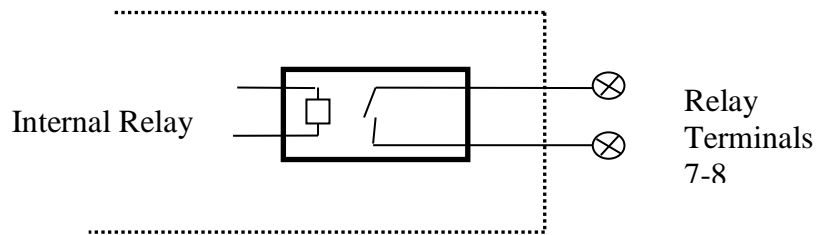

Relay 2 Connection

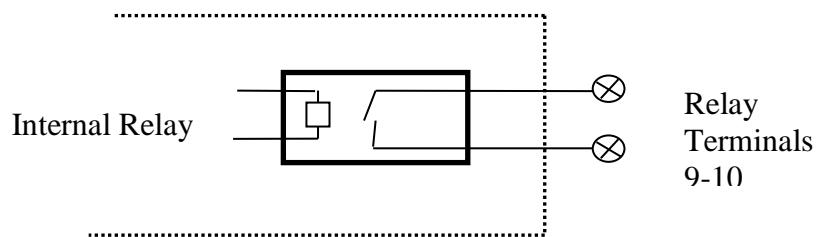

Relay 3 Connection

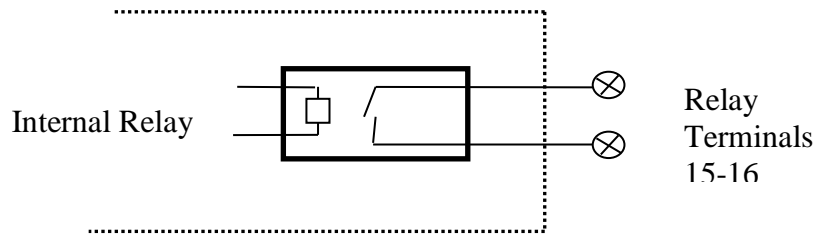

Relay 4 Connection

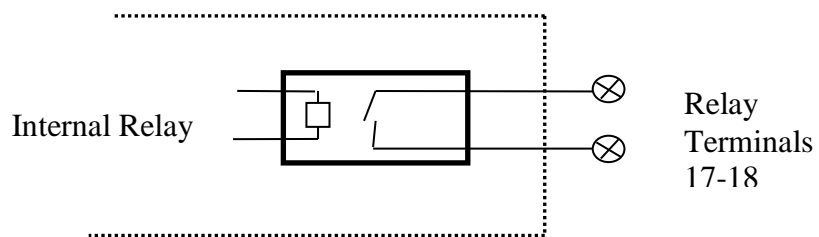

!! Important Note !!

A registered electrician must be used when connecting to the 120/240v main supply voltage.

Inputs

The SMS-TEMP-4 has two (3) Inputs and can be connected as per Fig1b or Fig 4

Fig 1a

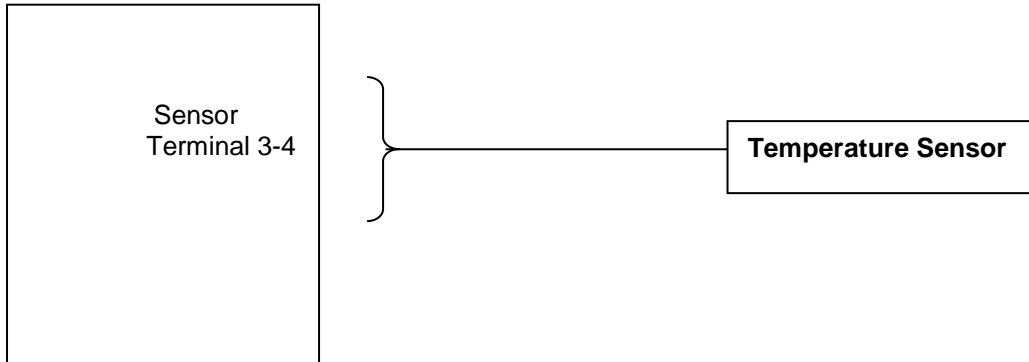

Fig 1b

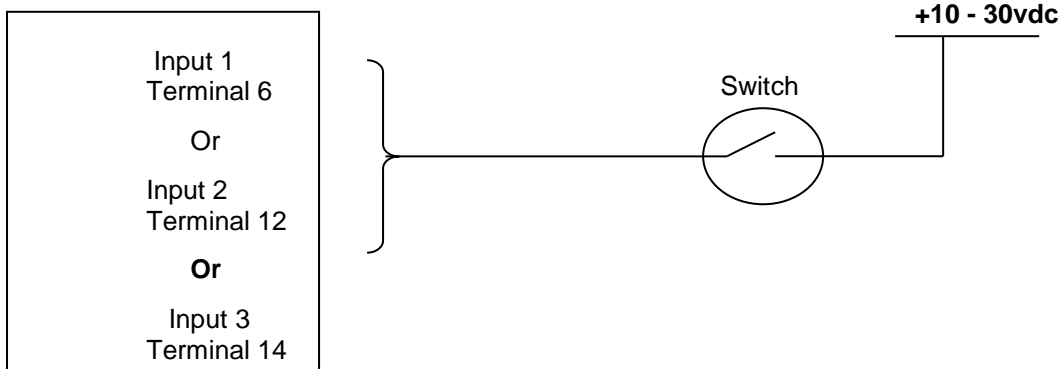
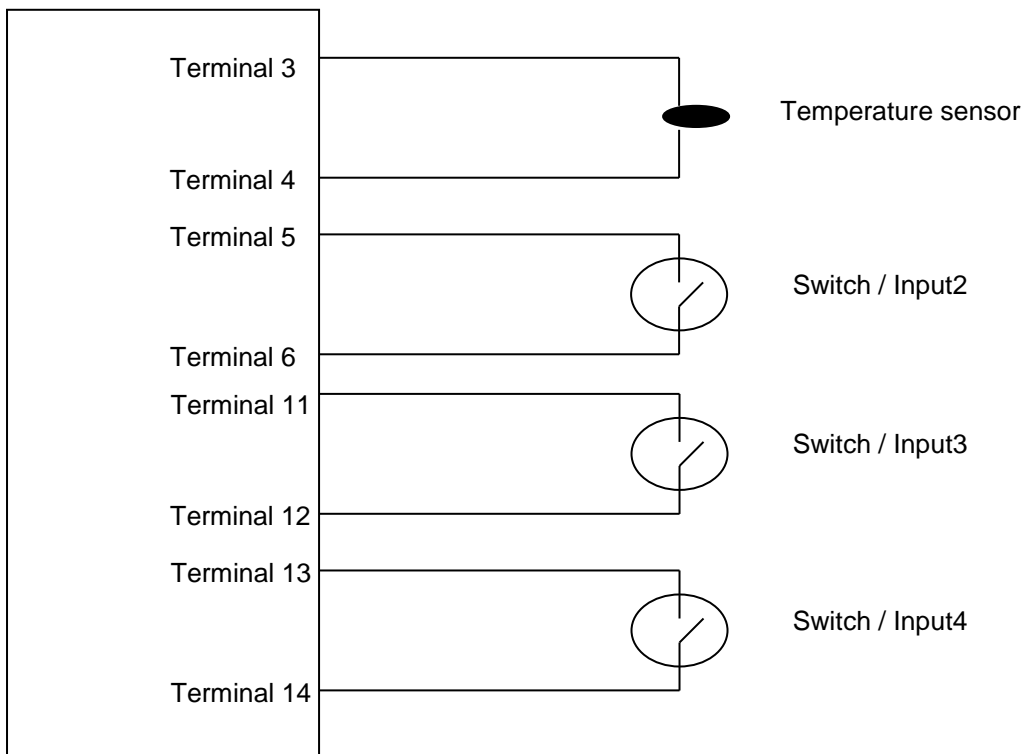

Fig 2



!! IMPORTANT !!**Setting up system for the first time:**

Please ensure the SIM card does NOT have a PIN number or is locked has been ACTIVATED with the network provider, insert into SIM slot on the back (see page 4) and power the unit up.

You must wait for the LED to be slowing flashing (EVERY 3 seconds) before sending any commands. Please wait a few minutes, as the unit will set auto-band and other details for the country.

IMPORTANT:

For all text commands, spelling and spaces must be strictly followed.

Setting up the first user (Once only command)**Command: Set user**

Note: the unit will pick up the users number from the incoming text.

When the Initial user setup has been successful the system responds with:

“ Your number has just been added to the user list”

Note: The initial user could be the installer who would set the system up, add other users (Add user page 8) and then remove his number (Remove user page 8).

Country Code:

?? Is the country code and XXXXXXXX is the mobile number without the preceding 0.

Examples:

New Zealand = 64 (+64 and the number without the preceding 0)

If the users number is 0411893070 then Command = add user +64411893070

Australia = 61 (+61 and the number without the preceding 0)

If the users number is 0414884900 then Command = add user +61414884900

Singapore =0065 (+65 and the number without the preceding 0)

If the users number is 0414884900 then Command = add user +65414884900

USA & Canada = 001 (+1 and the Area Code & Number)

If the users number is 414-555-1434 then Command = add user +14145551434

!! NOTE !!

If a user sends a text message to the system, which is not an exact match with the commands, the system responds with:

Sorry either that device does not exist or the message format is not understood, please check the spelling and try again

If anyone other than a programmed user sends a text message to the system, the system responds with:

Sorry you are not permitted to access this device

Commands

Adding a User (Note: Setting up the first user page 7 must be done first)

Command: Add user +??XXXXXXXX (see Country Code page 7)

If the user is already in the list, the system responds with:

Sorry +??XXXXXXXX is already active and cannot be added twice, please check the number and try again

If the number does not fit the checks, to confirm it is a valid number (all digits must be numbers excluding the leading +), the system responds with:

+??XXXXXXXX does not appear to be a valid number, please check that there are no letters or symbols in the number and try again

If the number does not lead with a +, the system responds with:

??XXXXXXXX does not appear to have the country code in international format (e.g. +??...) please check this and try again

However if everything is fine, the system responds with:

The user number +??XXXXXXXX has been added to the user list

Removing a User

Command: Remove user +??XXXXXXXX (see Country Code page 7)

If you try to remove the only user, the system responds with:

Cannot delete the only user.

If the number sent is not currently on the list, the system responds with:

+??XXXXXXXX is not currently in the user list so cannot be removed, please check the number and try again

If everything is ok, the system responds with:

The user number +??XXXXXXXX has been removed from the user list

Adding a Administrator

Command: Add admin +??XXXXXXXX (see Country Code page 7)

The system responds with:

The number +??XXXXXXXXXXXX has been set as the system administrator

If the admin has already been set, the system responds with:

The administrator number +??XXXXXXXXXXXX has already been set

If an administrator number is set then this is the only number the system will accept commands from. Other user will be sent texts but CAN NOT send any commands.

Removing a Administrator**Command: Remove admin**

The system responds with:

The administrator number and feature has been removed

Note: this completely removes the administrator from the user list, it does NOT move the user down a security level to normal "user" unless the administrator is the only number in the system in which case it will move the user from administrator to user.

The system responds with: **This number has been changed from administrator to a user**

Get a list of all the Users**Command: User list**

The system responds with:

User list is: +??XXXXXXXX +??XXXXXXXX ... (up to 5 numbers)

If there are too many numbers to display in one txt, a second txt will be sent showing the last two numbers

First text followed by:

+??XXXXXXXX +??XXXXXXXX +??XXXXXXXX ...

Turn programmed numbers lookup on or off**Command: User lookup on (or) off** (System default = On)

If User lookup is **On** the SMS-TEM-4 will only respond to numbers that have been programmed into the unit using the Add User command as per above.

If User lookup is **Off** the SMS-TEM-4 will respond to any number that sends the correct command.

The system responds with:

The user lookup list feature has been turned on and the unit will only accept commands from programmed users

OR

The user lookup list feature has been turned off and the unit will only accept commands from any numbers

PLEASE NOTE: Input changes will only be sent to users that have been programmed into the unit.

Text all programmed numbers on or off**Command: Text all on (or) off** (System default = On)

If Text all is **On** the SMS-TEM-4 will text all user that have been programmed into the unit with the reply to the command.

If Text all is **Off** the SMS-TEM-4 will only text the number that initiated the command with the reply.

The system responds with:

All users in the list will now receive notification texts (On)

OR

Only the number sending the text command will receive notification text (Off)

PLEASE NOTE: This command does not affect the inputs all Input changes will only be sent to users that have been programmed into the unit.

Turn all Input Text's OFF

With alerts turned off the device will NOT text every time any Input changes but the Inputs are still active so you can send a "Input status" query at any time. Linked outputs will not work.

Command: Alerts off

The system responds with: **Alerts have been disabled** (this is saved to memory and will still be disabled even after the unit is reset or rebooted)

OR

Command: Alerts off exc links (note only available in ver 1.2 or higher)

The system responds with: **Alerts have been disabled but linked outputs will still work**
If an input is triggered no alert text will be sent but if the input has a link to an output that output will activate.

Turn all Input Text's ON**Command: Alerts on**

The system responds with: **Alerts have been**

Testing**Command: test** (only run this if you are present and can trigger the inputs)

The system responds with: Battery is currently ???.? volts, signal strength is ?? % , run test now. The unit will now test the inputs and outputs and waits for the inputs to be triggered.

When input1 is turned on output1 will turn on, when input1 is turned off output1 will turn off
When input2 is turned on output2 will turn on, when input2 is turned off output2 will turn off
When input3 is turned on output3 will turn on, when input3 is turned off output3 will turn off
When input4 is turned on output4 will turn on, when input4 is turned off output4 will turn off
Test finished

If the input or inputs are not triggered this command will time out after 1 minute.

Get a list of the Inputs**Command: Input status**

Currently, **INPUT NAME** is ??, **INPUT NAME** is ??

Where ?? is either On or Off

If an Input is a latching input and on:

Currently the latching Input **INPUT NAME** is on and latched

If an Input is a latching input and off:

Currently the latching Input **INPUT NAME** is of

Get a list of the Outputs**Command: Output status**

The system responds with:

Currently, **Output Name** is ??, **Output Name** is ??

Where ?? is either On of Off

Naming Inputs and Outputs and Changing Names:

Command for initial Naming or changing name of Input or Output:

Note: The system default names are:

Inputs: Input1, Input2, Input3, Input4

Outputs: Output1, Output2, Output3, Output4

The name can contain a dash (-) but NOT a space or underscore. eg. "Pond-pump" is OK

The product does not support special characters.

Command:

Change **Current Input or Output Name** to **New Input or Output Name**

(Example: Change input1 to Alarm)

(Example: Change output1 to Pump)

This command is used to change Inputs and Outputs to a new name. Names can be words up to a total length of 20 characters, please **note** the name can contain a dash (-) but NOT spaces. Once the name has been changed, the particular Input or Output is always referred to by the new name (e.g. Alarm). For commands or status interrogation and the SMS-TEM-4 will respond using the new name. Use table on page 22 to record your new Input and Output names.

If the device you are trying to rename is not currently in the list, the system responds with:

Sorry either that device does not exist or the message format is not understood, please check the spelling and try again

If the new name chosen does not fulfill the requirements of a name, the system responds with:

Sorry that name is not allowed, please check that it is between 1 and 20 characters long

If everything is ok, the system responds with:

The input name has been changed to YYYYYYYYYY

Or

The output name has been changed to YYYYYYYYYY

Change the Input Delay (see page 22 for detailed explanation)
(You can have a delay when an Input turns either On or Off)

Command: Change **INPUT NAME** on delay to XX sec or min

(Example: Change input1 on delay to 10 min)

Command: Change **INPUT NAME** off delay to XX sec or min

(Example: Change input1 off delay to 10 min)

(XX can be between 1 and 99 seconds or 1 to 99 minutes)

The system responds with:

The **INPUT NAME** (On or OFF) delay has been set to XX (sec or min)

If XX is not between 1 and 99 or no value is entered, the system responds with:

Because no value was set the **INPUT NAME** (On or OFF) delay has been set to 30 secs

Change Input to Normally Open or Normally Closed**Command: Make INPUT NAME active open (or) closed**

This command is used to define if the switch wired to the Input is normally open or normally closed. The Input defaults are set for a normally open switch (which is active closed). That is, the Input becomes active when the switch is closed.

Active closed means: the Input switch is normally open and goes closed to activate Input.
Active open means: the Input switch is normally closed and goes open to activate Input.

The system responds with:

INPUT NAME will now activate when the input (either opens or closes)

OR if you try to set it for its current setting, the system responds with:

INPUT NAME is all ready set for (either open or closed) and does not need changing

Set an Input as a latched Input**Command: Make INPUT NAME latching (Example: Make alarm latching)**

This sets the Input to a latched Input and the system responds with:

The Input INPUT NAME is now a latching input

Set an Input as a Non-latched Input**Command: Make INPUT NAME nonlatching
(Example: Make alarm non-latching)**

This sets the Input to a NON latched Input and the system responds with:

The Input INPUT NAME is now a nonlatching input

Reset a latched Input (used to return Input to “non-activated” state)**Command: Reset INPUT NAME (Example: Reset alarm)**

The system responds with:

INPUT NAME is no longer in a latched state and will begin to be monitored again

If the Input is not latched, the system responds with:

INPUT NAME latch is not currently set so does not need clearing

Note: If the input is set as a tick-off input then by resetting the input (as above) it will also tick-off the input. If the input has been linked to an output then resetting the input will also reset the output.

Masking Input's (only available in ver 1.6 or later)

This feature allows for the individual inputs to be masked per programmed user, so only the set inputs will be sent to the programmed number.
 (System default is for all users to received texts from all inputs)

Command: Set +??XXXXXXXX inputs 1,3

This will set the system so that ONLY inputs 1& 3 will be texted to the number ??XXXXXXXX

The system responds with:

The inputs for user number +??XXXXXXXX have been set

To set back to factory default: Set +??XXXXXXXX inputs 1,2,3,4

Link an Input to an Output

Command: Link INPUT NAME to OUTPUT NAME

(Example: Link alarm to siren)

The system responds with:

The INPUT NAME has been linked to OUTPUT NAME

To clear a link

Command: Clear INPUT NAME link (Example: Clear alarm link)

The system responds with:

The link between INPUT NAME and OUTPUT NAME has been cleared

Function: If a link is setup between an Input and an Output and the Input is turned ON, the Output will also turn on. Full control of the Output is still available.

Get Linked information

Command: Link status

The system responds with:

Which inputs are linked to which outputs

Input Tick Off Feature.

The inputs can have a Tick-Off feature, if this feature is turned on and an input is on the unit will send a reminder text every 5 minutes until the text command "Tick INPUT NAME off is sent. (max number of texts=20)

To turn the feature on:

Command: Make INPUT NAME tickoff on

If everything is fine, the system responds with:

The input tickoff feature has been turned on

To turn the feature off:

Command: Make INPUT NAME tickoff off

If everything is fine, the system responds with:

The input tickoff feature has been turned off

To Tickoff an input

Command: Tick INPUT NAME off

If everything is fine, the system responds with: **The input has been ticked off**

NOTE: If the input is a latched input sending the tickoff will NOT reset the latch, the command Reset input name will need to be sent.

Programming the Input reply message. (ver 2.4 and above only)

All inputs can have a programmed reply message feature, if this feature is programmed then when the input is triggered (turned on) you will receive the programmed message. And when the input is turned off **NO** message will be sent

The programmed message can have up to 6 words and a maximum of 10 characters per word:

e.g Turn the back paddock pump on
e.g Please close the gate after using

To program the feature:

The Command for Input1 is: Message1 please close the gate after using

The Command for Input2 is: Message2 please close the gate after using

The Command for Input1 is: Message3 please close the gate after using

The Command for Input2 is: Message4 please close the gate after using

If everything is fine, the system responds with:

The reply message has been set to : please close the gate after using

To turn the feature off and set back to factory settings simply send:

The Command for Input1 is : Message1

The Command for Input2 is : Message2

The Command for Input1 is : Message3

The Command for Input2 is : Message4

If everything is fine, the system responds with:

The reply message has been set back to the factory settings

If the message is wrong, the system responds with:

Sorry that message is not allowed, please check that each word is between 1 and 10 characters long

Turn an Output ON or OFF

Command: Turn OUTPUT NAME on (or) off (Example: Turn Generator on)

If everything is fine, the system responds with:

OUTPUT NAME has been turned off (or) on

This command is used to turn on/off Outputs. If the item named is not an Output or the command is not spelt correctly the system responds with:

Sorry either that output does not exist or the options ON or OFF has not been use

Turn an Output ON for XX mins or hrs or days

Command: Turn OUTPUT NAME on for XX (either mins or hrs or days)

If everything is fine, the system responds with:

OUTPUT NAME has been turned on for XX (mins or hrs or days)

XX can be between 1 to 99 either minutes or hours or days (max time 99 days)

If no time is specified then the output will be turned on until the "Turn output Off " command is sent

The Output on time XX can also be programmed so when ever the "Turn output On command is sent the output will turn on for the programmed time

Command: Set OUTPUT NAME on time to XX (mins or hrs or days)

If everything is fine, the system responds with:

The OUTPUT NAME on time has been set to XX (mins or hrs or days)

If no value is set the system will respond with:

The OUTPUT NAME has been turned on and will stay on because no time-out value was set

If the text mins or hrs or days does not follow the XX (time) the system will respond with:

Sorry you can only set mins, hrs or days please check the spelling and try again

Change Output to Normally On or Normally Off

Command: Make OUTPUT NAME inverted

This command is used to define if the output relay is normally open or normally closed. System default is normally open.

The system responds with:

The OUTPUT NAME is now inverted

To non-invert the output:

Command: Make OUTPUT NAME noninverted

The system responds with:

The OUTPUT NAME is now noninverted

Make an Output pulse On and Off

Command: Make OUTPUT NAME pulse XX secs

This sets the output pulse time, XX can be between 1 and 99 seconds

When the Output ON command is sent as follows:

Turn OUTPUT NAME On

The Output will turn On for the programmed pulse time and then turn Off, the system responds with:

OUTPUT NAME has been pulsed on and off

If you try and set an Input as a pulse Output, the system responds with:

Sorry pulses only apply to outputs, please check the name and try again

If the Output is already a pulsed Output the system responds with:

OUTPUT NAME is already a pulsed output so does not need changing

If the Output is initially off and everything goes correct, the system responds with:

OUTPUT NAME is now a pulsing output

If the pulse time has not been set as per above the default time is 3 seconds and the system responds with:

OUTPUT NAME is now a pulsing output with a default pulse time of 3 seconds

If the Output was initially On when the Output was set, the system responds with:

OUTPUT NAME is now a pulsing output and has been turned off in preparation for use

If the Output is linked to an Input, when the Input is triggered the system sends:

INPUT NAME linked output OUTPUT NAME has been pulsed on then off

Clear Output pulse (make output non pulsing)

Command: Clear OUTPUT NAME pulse

If you try to clear a pulsed Output when it is not set, the system responds with:

OUTPUT NAME is not currently a pulsed output so does not need changing

If you try and clear a pulse on an Input, the system responds with:

Sorry pulse only apply to outputs, please check the name and try again

Otherwise if its all ok, the system responds with:

OUTPUT NAME is no longer a pulsing output

Make an output public

This command is used to make an output public, which means it can be controlled by anyone and not just a programmed user. This could be used for a gate for example.

To set the output feature on:

Command: Make OUTPUT NAME public

The system responds with: **The output OutputName is now a public output**

To set the output feature off:

Command: Make OUTPUT NAME private

The system responds with: **The output OutputName is now a private output**

Turn Output response On / Off

This command is used to turn the output response text On or Off.

If the output response is turned off then a response text is not sent when outputs are turned on or off System default is ON (send response).

To turn the feature on:

Command: Turn respond on

The system responds with: **This feature has been enabled, response text will be sent**

To turn the feature off:

Command: Turn respond off

The system responds with: **This feature has been disabled, response text will not be sent**

Save Output Status

This command is used to define if the output state is saved to memory and restored to its state after a power recycle. E.g. if an output was On when the power was turned off then when the power is restored the output will turn back on. Note this does not apply if an output was turned on for a specified time. System default is not saved.

Command: Make OUTPUT NAME save

The system responds with:

The output condition will be saved and restored if the power is reset

To turn the feature off:

Command: Make OUTPUT NAME nonsave

The system responds with:

The output condition will not be saved

Note: If you want this for both outputs then the command needs to be sent for both outputs

Link Outputs _____ (only available in ver 1.2 or later)

This command is used to link outputs together.

To link outputs:

Command: Link outputs ? ? ? e.g. Link outputs 1 & 4 : **Command: Link outputs 1 4**

The system responds with: **The outputs have been linked**

To clear links:

Command: Clear linked outputs

The system responds with: **All linked outputs have been cleared**

Set Battery Alarm Trigger Voltage

Command: Change battery alarm to XX.X

Where XX.X can be between 8 and 30 volts

The system responds with:

The low voltage alarm has been set to XX.X volts and the alarm has been reset

This system monitors the battery by calculating the average value of the supplied voltage over the previous 1 minute period. Once this average has been detected to be below the set value for the programmed time it sends a text message to inform all users. The inclusion of the running average helps protect the system from detecting inaccurate readings during periods of increased load.

If no value (XX.X) is set the system responds with:

Because no value was specified the voltage alarm has been set to 11.5 volts and the alarm has been reset

If the value (XX.X) is outside the settings the system responds with:

Because the value is out of range the voltage alarm has been set to 11.5 volts and the alarm has been reset

Link the Battery Alarm to an Output

Command: Link battery alarm to OUTPUT NAME

The system responds with:

The battery alarm has successfully been linked to OUTPUT NAME and the alarm has been reset

To clear or remove the link

Command: Clear battery link

The system responds with:

The battery alarm Output link has been removed

Function: If a link is setup between the Battery Alarm and an Output, then when the Battery Alarm turns ON, the linked Output will also turn on. Full control of the Output is still available (see page 15-16).

Check the Battery Supply Voltage

Command: Voltage status

The system responds with: (where battery is the name for the supply voltage)

Battery is currently XX.X volts

Set the battery alarm as a latched or non-latched alarm

If the battery alarm is set to latching then once the battery alarm has been triggered the **Reset Battery Alarm** command needs to be set to reset the latched alarm. If it is set to non-latching the battery alarm will reset once the battery voltage has increased by .5 volts. The system default is non-latching:

Command: Make battery alarm latching

System responds with: **The battery alarm is now latching**

Command: Make battery alarm nonlatching

System responds with: **The battery alarm is now non-latching**

Reset a latched Battery Alarm (if set to latching alarm)

Command: Reset battery alarm

This command is used to clear the Low Battery Voltage alarm, after it has alerted the user that the voltage has dropped below the set level.

The system responds with:

The battery alarm has been cleared and will begin to be monitored again

If the alarm is linked to an output the system responds with:

The battery alarm has been cleared and will begin to be monitored again, the linked output has also been turned off

If the alarm is not currently set, the system responds with:

The battery alarm is not currently active and does not need to be cleared

Alive text feature. (only available in ver 1.2 or later)

This unit has an alive text feature which will send out a alive text as often as it has been programmed for.

To turn the feature on:

Command: Turn alive text on every xx yy (where xx=1 to 99, yy = hrs or days)

This sets how often the alive text is sent out, XX can be between 1 and 99

Example: Turn alive text on every 2 days
Every 2 days the Alive text will be sent out

If everything is fine, the system responds with:

This feature has been set, the following text will be sent every xx yy (yy = hrs or days)

Alive text, battery is currently xx.x volts, signal strength xx %

The default setting will send the Alive text to **All** users, to mask users see page 20

To turn the feature off:

Command: Turn alive text off

If everything is fine, the system responds with:

This feature has been disable

Masking Alive texts. (only available in ver 1.6 or later)

This feature allows you to mask the Alive text so only the programmed users will receive the Alive text and not all users. The default setting is all users will receive the alive text but once this command has been sent only the programmed numbers will receive the text.

To set mask:

Command: Add +??XXXXXXXXXX to alive text (example +6442934211)

This will set the mask and only the number as per above will receive the alive text, repeat this for all users that require the alive text.

If everything is fine, the system responds with:

The number has been added to the alive text list

Get Firmware Version

Command: Ver

The system responds with: **SMS-TEMP-4 Ver X.X**

Get Signal Strenth

Command: Sig

The system responds with: **Currently the signal strength is XX %"**

Resetting the Unit

Command: Reboot

The system responds with: **Module is now resetting**

Reset Unit to Factory Defaults

-----**WARNING**-----

This command restores the unit to factory defaults therefore all settings will be lost

Command: Factory Reset

The unit responds with:

The unit has been restored to factory settings and all memory has been cleared

Get Temperature (Temperature range -25 to 80 degrees C)

You can text and get the current temperature at any time.

Command: Temp

The system responds with:

The temperature is xx Degrees (where xx is the temperature in degrees C)

Set alarm temperatures (see page 25 for details)

Both low and high alarm levels can be set, the unit will text you when the level has been reached.

Command: Set temp yyy alarm to xxx degrees

(where yyy is either high or low, xx is the temperature) Note if a minus temperature is required place the – symbol before the temperature. E.g **Set temp yyy alarm to -20 degrees**

The system responds with:

**The temperature yyy alarm has been set to xxx degrees and the alarm has been turned On
(where yyy will be either low or high depending on the above)**

Set alarm reset temperatures

Both low and high alarm temperatures will be automatically reset approx. 3 degrees above or below the temperatures depending on if the alarm is low or high OR the reset levels can be programmed.

Command: Set temp yyy reset to xxx degrees

(where yyy is either high or low, xx is the temperature) Note if a minus temperature is required place the – symbol before the temperature. E.g **Set temp yyy alarm to -20 degrees**

The system responds with:

**The yyy temp alarm reset temperature has been set to xxx degrees
(where yyy will be either low or high depending on the above)**

Turning temperature alarms On / Off

The temperature alarms can be turned On or Off.

Command: Temp xxxx alarm yy (xxxx can be the word low or high : yy can be on or off)
e.g Temp high alarm off

The system responds with:

The temperature xxx alarm has been turned yy, (where yy is either on or off)

Set alarm temperatures On and Off delays (available in ver 3.3 or latter)

Both high and low alarms can have an On and or Off delays attached.

There are four delays. Eg Low **On** delay / Low **Off** delay, High **On** delay / High **Off** delay.

As an example if the Low On delay was set to 2 minutes then when the alarm point temperature is reached the system will wait 2 minutes before sending out the alarm text, if the temperature returns during this delay then no text will be sent.

Command: Set xxx temp yyy delay to zzz mins

(where xxx is either high or low, yyy is either on or off and zzz is the time in minutes)

e.g Set low temp on delay to 5 mins

The system responds with:

The low alarm delay on time has been set to 5 mins

Linking alarms to outputs

Both low and high alarm can be linked to an output.

Command: Link xxxx alarm to OUTPUT NAME (xxxx can be the word low or high)

OUTPUT NAME = the name of the output

The system responds with:

The temperature xxxx alarm has been linked to OUTPUT NAME
(where xxx will be either low or high depending on the above)

Clearing linked alarms

This command will remove any programmed link to an output.

Command: Clear xxxx alarm link (xxxx can be the word low or high)

The system responds with:

The xxxx alarm output link has been removed
(where xxx will be either low or high depending on the above)

CONDITIONS OF WARRANTY

Penguin Electronics Ltd (the manufacturer) warrants that all of its products are free of defects. Any apparent fault will be rectified free of charge by Penguin Electronics Ltd for a period of 12 months from purchase date, provided that:

- ❑ All costs of installation, cartage, freight, travelling expenses and insurance are paid by the customer
- ❑ The liability of Penguin Electronics Ltd under these Conditions Of Warranty is limited to any defective components or workmanship directly attributed to the manufacture of this product
- ❑ The manufacturer's liability under this warranty is limited to the replacement of defective parts (or at our option, replace) without charge where determined by the manufacturer
- ❑ Where a replacement unit is provided the manufacturer is entitled to and will retain the replaced product as its property
- ❑ The equipment has been installed correctly and is used in accordance with the instructions issued with the product

In no event will Penguin Electronics Ltd or its agents accept any liability for any direct, indirect or consequential losses or damages whatsoever or howsoever arising from the use of the product.

Where conditions or warranties are implied or other rights are given in respect of these Conditions of Warranty under the Trade Practices Act or any other laws they are, to the extent permitted by such laws, excluded. Where such conditions, warranties or rights are not able to be excluded, Penguin Electronics Ltd liability for any breach of any such condition or warranty shall, to the extent permitted by such laws, be limited to the repair or replacement of the equipment. These conditions may only be varied with the written approval of the directors of Penguin Electronics Ltd.

Appendix One: Record Your Names for all Inputs and Outputs

Input	Default Name	[Name] (Up to 20 characters)	Latched Yes No	Linked to	Active Open or Closed
1	input1				
2	Input2				
3	Input3				
4	input4				
Output					
1	output1				
2	Output2				
3	Output3				
4	output4				

Detailed explanation of Input delays:

On Delay:

This delay is used when the input turns ON:

Example : If input1 has an ON delay of 10mins, when Input1 turns ON the unit will wait 10 minutes then send the following text message "Input Name has been turned on"

If the input turns back off before the programmed time delay expires the input is reset and the time starts back at zero.

If the input is linked to an output it will also state the linked output has also been turned on

Off Delay:

This delay is used when the input turns OFF:

Example : If input1 has an OFF delay of 10mins, when Input1 turns OFF the unit will wait 10 minutes then send the following text message "Input Name has been turned off"

If the input turns back on before the programmed time delay expires the input is reset and the time starts back at zero.

If the input is linked to an output it will also state the linked output has also been turned off

Detailed explanation of alarm points:

High alarm temp in + degrees area.

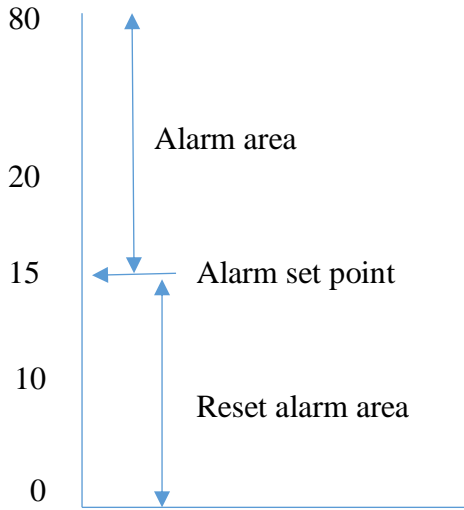

High alarm temp in – degrees area

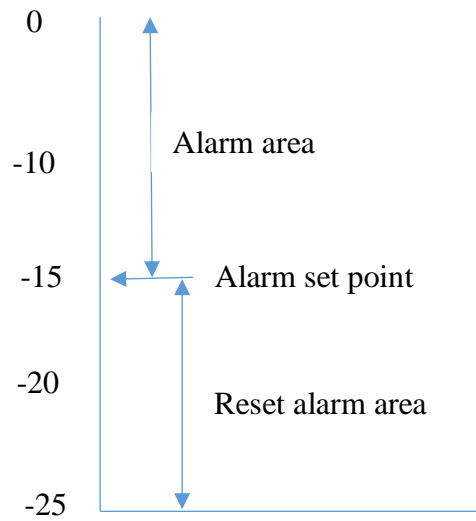

High Alarm: The unit will alarm if the current temperature is equal to or greater than the programmed high set point temperature.
 e.g set point = +15 degrees, alarm point will be equal or greater than +15 degrees.
 e.g set point = -15 degrees, alarm point will be equal or less than -15 degrees.

Low alarm temp in + degrees area.

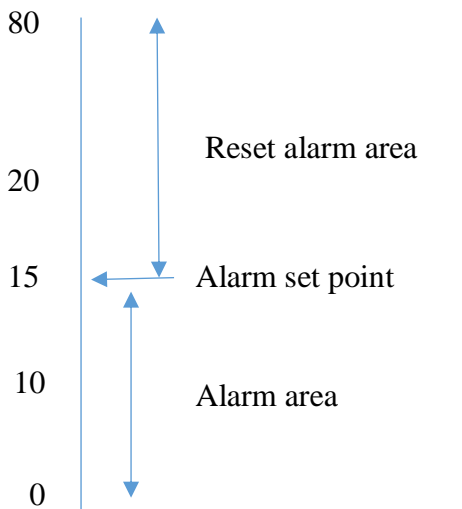

Low alarm temp in – degrees area

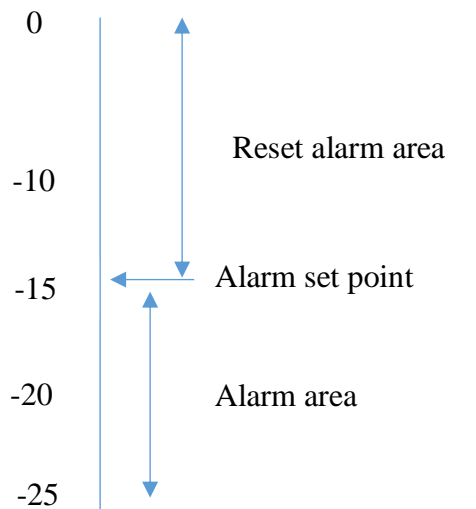

Low Alarm: The unit will alarm if the current temperature is equal to or less than the programmed low set point temperature.
 e.g set point = +15 degrees, alarm point will be equal or less than +15 degrees
 e.g set point = -15 degrees, alarm point will be equal or greater than -15 degrees .

Trouble Shooting Guide

PROBLEM	CAUSE	POSSIBLE SOLUTION
LED not flashing	No power	Check power supply
LED fast flashes (every 1 second) and never slow flashes (every 3 seconds)	Cannot find the GSM network	<ol style="list-style-type: none"> 1. Replace aerial with high gain aerial 2. Move unit to different location 3. SIM card not installed 4. SIM has a pin number (remove) 5. SIM is locked (remove lock)
LED slow flashes (every 3 seconds) But no texts are sent or received	The unit can find the GSM network (hence the slow flashes) but the signal strength is to low	<ol style="list-style-type: none"> 1. Replace aerial with high gain aerial 2. Move unit to different location 3. SIM card NOT registered with the network provider 4. No credit on the SIM card

Appendix Two: SMS-TEM-4 Application Notes

Simple Shore Power Monitoring

An inexpensive and effective means to monitor your vessel's shore power connection is to purchase a 12v DC power supply as typically used to power cordless phones or video games - the type normally available at retailers and electronics suppliers. This unit is plugged into a conveniently located 120/240v AC outlet on-board your vessel and wired as shown in the diagram below (fig. 1). Name this Input Shore Power using the Command on page 10. If shore power is lost, the SMS-TEM-4 will send a text message to all "users" saying "Shore Power has turned off". To avoid any nuisance text message's caused by a tripped breaker, or someone temporarily using your power outlet, you should set the **OFF** delay for this Input (a 15 minute delay is appropriate for most situations). To set the delay, simply send a text command "Change Shore Power off delay to 15 min" as shown on page 11.

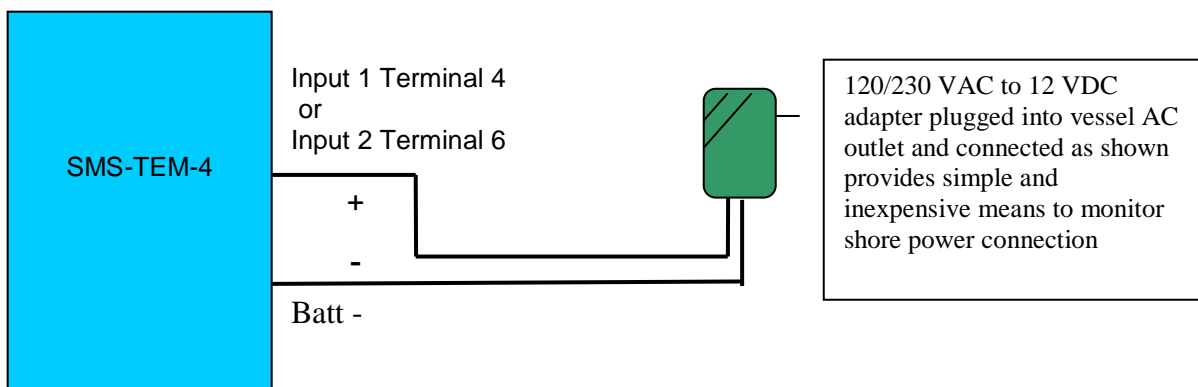

Figure 1

Fixed Wiring Shore Power Monitoring (requires a registered electrician)

We recommend using the N/C and Common contacts

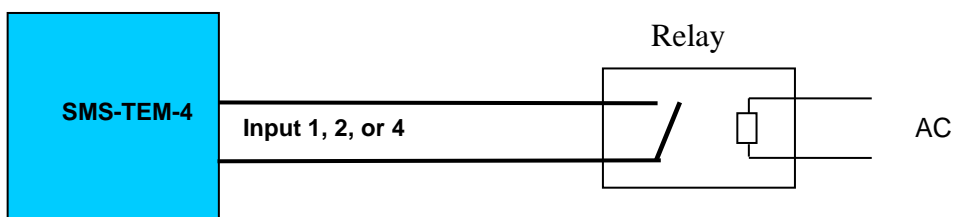

Figure 2

! Important Note !

A registered electrician must be used when connecting to the mains supply voltage.

Intruder Alarm Systems

The following configurations define possible solutions for intruder alarms. Like all other alerts provided by the SMS-TEM-4, these should be disabled prior to you entering the premises. This is easily accomplished by issuing the text command: **Alerts off** when leaving the premise, simply issue the text command: **Alerts on**

Connecting to a PIR motion sensor

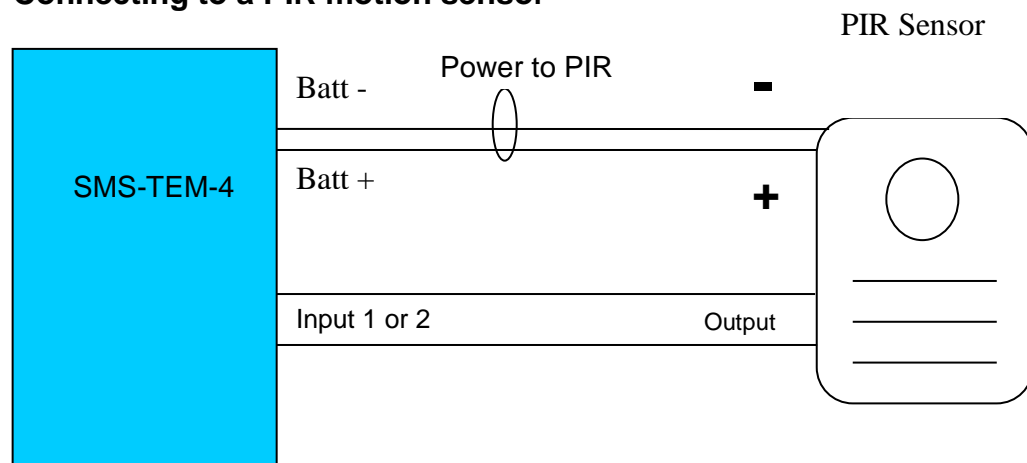

Commands

Send command text: Change input? to **Sensor**

Send command text: Make **Sensor** latching

Send command text: Make **Sensor** active open (most PIR are normally closed and go open when activated)

When the unit detects movement you will receive the following text message:

“The input **Sensor** has been turned on and is now latched”

When the alarm has been triggered you can reset it by sending the txt: **Reset Sensor**

If you want to connect a siren and/or flashing light to output1 then:

Send command text: Link **Sensor** to output1

Send command text: Change output1 to **Siren**

When the unit detects movement you will receive a text message and the siren and/or flashing light will turn On.

“The input **Sensor** has been turned on and is now latched. Linked output **Siren** has also been turned on”

When the alarm has been triggered you can reset it by sending the txt: **Reset Sensor or the siren can be turned off by sending the command: **Turn siren off****

Note: The command: **Reset sensor** will still need to be sent to reset the system even though the siren has been turned off (to unlatch the sensor Input).

Door and Window Alarms

Alarms sensors for doors and windows generally consist of magnetically held switches. The contacts are normally-closed (NC). If a door/window is opened the circuit is opened generating an alarm. An alarm is also generated if the wire is cut between the sensor and the monitoring system opening the circuit. This prevents an intruder from defeating the alarm system by merely cutting a wire. The wiring diagram for the window/door switches is similar to the motion detector and the same basic commands are used to set up the motion detector.

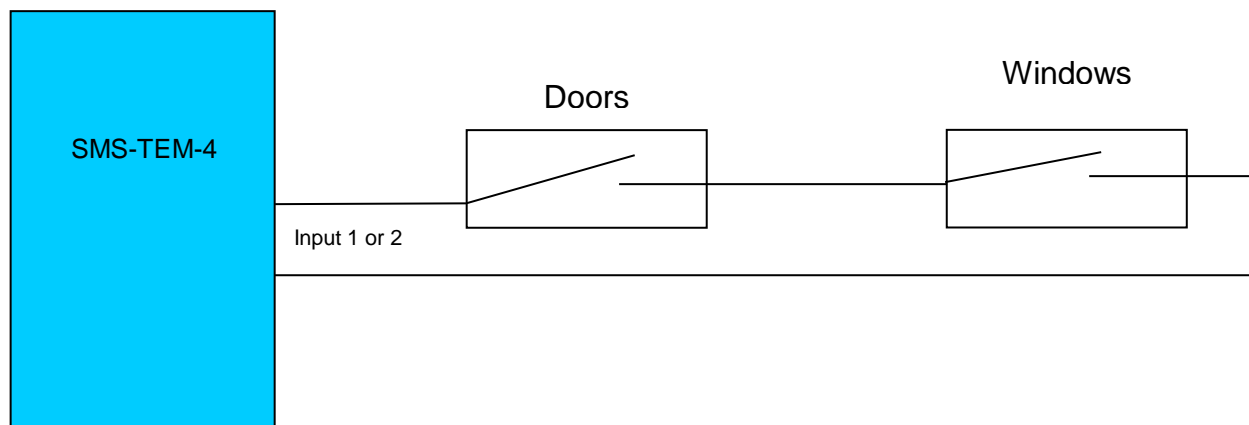

Send command text: Change input? to **Door Sensor**

Send command text: Make **Door Sensor** latching

Send command text: Make **Door Sensor** active open (sensors are normally closed and go open when activated)

When the unit detects movement you will receive the following text message:

“The input **Door Sensor** has been turned on and is now latched”

When the alarm has been triggered you can reset it by sending the txt: **Reset Door Sensor**

If you want to connect a siren and/or flashing light to output1 then:

Send command text: Link **Door Sensor** to output1

Send command text: Change output1 to **Siren**

When the unit detects an intruder you will receive a text message and the siren and/or flashing light will turn On.

“The input **Door Sensor** has been turned on and is now latched. Linked output **Siren** has also been turned on”

When the alarm has been triggered you can reset it by sending the txt: **Reset Door Sensor or the siren can be turned off by sending the command: **Turn Siren off****

Note: The command: Reset **Door Sensor** will still need to be sent to reset the system even though the siren has been turned off.

Air Conditioners / Heating

Different brands of Air-Con's use different means of remotely turning On and Off.

Type1:

If the brand requires that the Output to be turned On and left On then you can use either Output 1 or 4.

eg. Turning the output relay On will start the Air-Con and turning the relay Off will stop the Air-Con.

1. Change the Output name as per page 11:

Naming Inputs and Outputs and Changing Names

4. Turn output On as per page 15:

Turn an Output ON or OFF

4. Turn output Off as per page 15:

Turn an Output ON or OFF

Type4:

If the brand requires that the Output be pulsed On and Off to turn the Air-Con On and pulsed On and Off to be turned Off. The SMS-TEM-4 has a special command for this type.

1. Connect the Air-Con to Output1
2. To turn On send : Air On (Output1 will pulse On and Off triggering the Air-Con On)
3. To turn Off send: Air off (Output1 will pulse On and Off triggering the Air-Con Off)

Type4: Heating

If the brand requires that the Output be pulsed On and Off to turn the Heating On and pulsed On and Off to be turned Off. The SMS-TEM-4 has a special command for this type.

4. Connect the Heating Input trigger to Output1
5. To turn On send : Heating On (Output1 will pulse On and Off triggering the Heating)
6. To turn Off send: Heating off (Output1 will pulse On and Off triggering the Heating)

Please Note: This special command only works with Output1

©

All technologies, design and Intellectual property is owned by
Penguin Electronics Ltd
New Zealand
Version 1.1